



# FS-i6

## Digital proportional radio control system

### INSTRUCTION MANUAL

### 用户手册

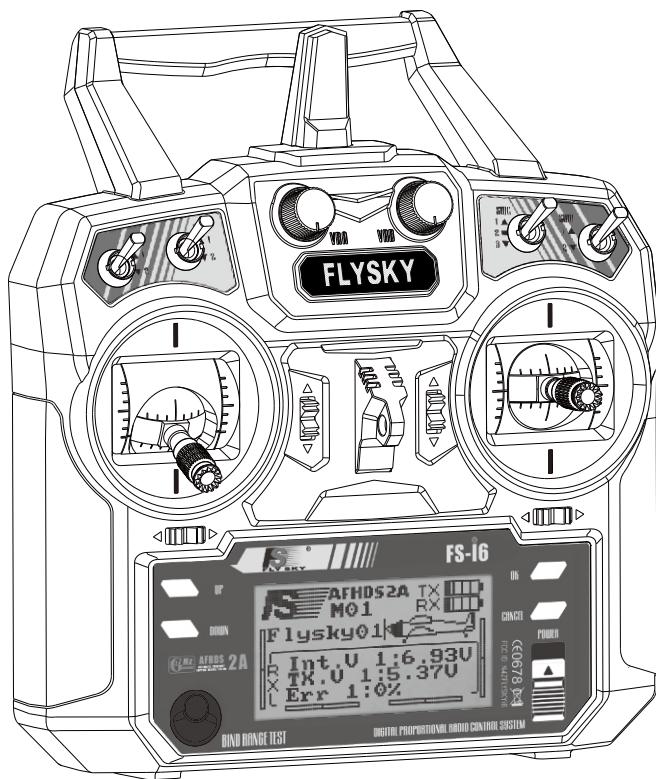

<http://www.flysky-cn.com>

Copyright ©2013-2017  
Flysky RC model technology co., ltd



# Table of contents

1. Introduction 简介 .....	2
2. Service 服务 .....	2
3. Special symbols 特殊标志 .....	3
4. Safety guide 安全指导 .....	3
5. 2.4GHz System 2.4G系统 .....	5
6. System characteristics 系统特征 .....	6
7. Transmitter specifications 发射机参数 .....	7
8. Receiver specifications 接收机参数 .....	7
9. RX setup introduction接收机操作说明 .....	8
10. Receiver and servo connections 接收机与伺服器连接 .....	9
10.01. Receiver and servo connections (aircraft) 接收机和舵机连接(飞机) .....	9
10.02. Receiver and servo connections(helicopter) 接收机和舵机连接(直升机) .....	9
11. 2.4GHz Operation notes 2.4G操作注意事项 .....	10
11.01. Binding 对码 .....	10
11.02. Power on 开机 .....	10
11.03. power off 关机 .....	11
12. Definition of key functions 按键定义 .....	11
13. Warning警告 .....	12
14. Main screen 开机画面 .....	13
15. Main menu 主菜单 .....	14
16. System settings 系统设置 .....	14
16.01. Model select 模型选择 .....	14
16.02. Model name 模型名称 .....	15
16.03. Type select 类型选择 .....	15
16.04. Model copy 模型复制 .....	15
16.05. Model reset模型重置 .....	16
16.06. Trainer mode 教练模式 .....	16
16.07. Student mode 学员模式 .....	16
16.08. Sticks mode 摇杆模式 .....	17
16.09. RX setup接收机设置 .....	17
16.10. LCD brightness 显示屏亮度 .....	20
16.11. Firmware version 固件版本 .....	20
16.12. Firmware update 固件升级 .....	20
16.13. Factory reset恢复工厂设置 .....	21
17. Functions settings 功能设置 .....	21
17.01. Reverse 正逆转 .....	21
17.02. End points 舵机最大行程 .....	22
17.03. Display 显示 .....	22
17.04. Auxiliary channels 辅助通道 .....	22
17.05. Sub trim 微调 .....	23
17.06. Dual rate / exponential 双重比例/指数 .....	23
17.07. Throttle curve 油门曲线 .....	23
17.08. Pitch curve (variable pitch helicopter only) 螺距曲线(仅适用于螺距可变直升机) .....	24
17.09. Swash AFR 直升机螺距混控系统 .....	24
17.10. Mix 混控 .....	24
17.11. Elevon (airplane only) 升降舵(仅适用于飞机) .....	25
17.12. V tail (airplane only) V型尾翼(仅适用于飞机) .....	25
17.13. Gyroscope (helicopter only) 陀螺仪(仅适用于直升机) .....	25
17.14. Switches assign 开关分配 .....	26
17.15. Throttle hold 油门锁定 .....	26
18. Packaging content 包装内容 .....	27
19. FCC Statement 声明 .....	27

## 1. Introduction 简介

Thank you for choosing the Fly Sky FS-i6 6 channels 2.4GHz AFHDS2A computerized digital proportional RC airplane and helicopter system. If it's your first use of a computerized radio system, this user manual will bring you easily to a new world of fun and sophistication. In all cases, please read carefully and completely this user manual as it contains all information to keep you safe.

感谢您选择富斯出品的FS-i6六通道2.4G可编程AFHDS2A第二代增强版自动跳频数字系统，该系统可兼容飞机和直升机两种模式。如果这是您第一次使用可编程遥控系统，这本使用手册将很快地带给您一个有趣又高端的全新世界。因此，为了确保您安全使用本产品，请仔细地完整阅读这本使用手册。

## 2. Services 服务

If you encounter any problem during use, please refer to this manual. If the problem still persists, please contact your local dealer or visit to our service and support website:

<http://www.flysky-cn.com>

如果您使用时遇到任何问题，请参照此说明书。如果您的问题仍然未能解决，请直接联系当地经销商或者我们网站上的客服人员。

<http://www.flysky-cn.com>

### 3. Special symbols 特殊标志

Please pay attention to the following symbols when they appear in the manual and read carefully.

当以下标志出现在说明书的时候请注意并且仔细阅读。



**Danger:**

Not following these instructions may expose the user to serious injuries or death.

如果使用者不按照说明方法操作，有可能导致使用者严重受伤，甚至致命的危险。



**Warning:**

Not following these instructions may expose the user to serious injuries.

如果使用者不按照说明方法操作，有可能导致使用者严重受伤。



**Attention:**

Not following these instructions may expose the user to minor injuries and even to serious injuries.

如果使用者不按照说明方法操作，有可能导致使用者外伤，甚至严重受伤。



**Prohibited**  
禁止



**Mandatory**  
强制

### 4. Safety guide 安全指导



Don't fly at night or in bad weather like rain or thunderstorm as this can cause erratic operation or loss of control.

请不要在夜晚或者雷雨天使用此产品，因为恶劣的天气环境有可能导致遥控设备失控。



Make sure moving direction of all motors be same with the operating direction. If not, please adjust direction first.

操控时，请先确认模型所有舵机的动作方向与操控方向一致。

如果不一致，请调整好正确的方向。



The shutdown sequence must be to first disconnect the receiver battery then to switch off the transmitter, if the transmitter is switched off while the receiver is still powered, it may lead to uncontrolled movement or engine start and may cause an accident.

关闭时，请务必先关闭接收机电源，然后关闭发射机，如果关闭发射机电源时接收机仍然在工作，将有可能导致遥控设备失控或者引擎继续工作而引发事故。



In particular, the 2.4G RC system will affect the plane or the car nearby after you turn on the transmitter.

特别要注意，如果附近有汽车正在运行或飞机正在飞行，开机后2.4 GHz RC系统可能会影响到他们。



Do not operate outdoors on rainy days, run through puddles of water or use when visibility is limited. Should any type of moisture (water or snow) enter any component of the system, erratic operation and loss of control may occur.



不要在户外雨天，有水的地方或当能见度有限的时候使用。  
可能水分(水或雪)会进入到系统内部，不稳定的运行和失控可能发生。

Do not operate in the following places:

Near other sites where other radio control activity may occur,  
Near people or roads,

On any pond when passenger boats are present,

Near high tension power lines or communication broadcasting antennas,

Interference could cause loss of control,

Improper installation of your Radio Control System in your model could result in serious injury.



不要操作在以下的地方：

基站附近或其他无线电活跃的地方，人多的地方或道路附近，

有客船的水域，高压电线或通信广播天线附近，干扰可能导致失控，

安装不正确，无线电控制系统可能导致模型发生严重的伤害。

Do not operate this R/C system when you are tired, not feeling well or under the influence of alcohol or drugs. Your judgment is impaired and could result in a dangerous situation that may cause serious injury to yourself as well as others.



当你感到疲倦，饮酒或吸毒后，不舒服的影响下，不要操作这个R / C系统。

判断力下降，而且可能发生危险的情况下，对自己或他人可能造成严重的伤害。

Do not touch the engine, motor, speed control or any part of the model that will generate heat while the model is operating or immediately after its use. These parts may be very hot and can cause serious burns.



当模型操作或使用后，请勿触摸发动机、电机、定速设定或任何可能发热的部分，  
这些部分可能非常热，会造成严重的烧伤。

Please have an overall check about the model before any operation.

Any problem in radio control system or improper installation may cause out of control.

Simple distance test methods:

One hold the model, and the other one carry the transmitter to a proper place to check the servo system condition.

Please stop operation if any exceptional case occurs.

Please check the model memory to make sure the matching is right.

总是在操作模型之前进行全面的检查。



无线电控制系统出现问题以及不正确安装，都有可能导致模型失控，

简单的距离测试方法：一个人把持模型另一个人持发射机走开，检查该伺服系统运转情况。

测试时要注意到若有异常出现，请不要操作模型。

也检查模型的记忆，以确保模型的匹配是适当的。

Turn on the power, please check if the throttle neutral position is in its lowest position while turning on the transmitter every time. When making adjustments to the model, do so with the engine not running or the motor disconnected, you may unexpectedly lose control and create a dangerous situation.



开机时，每次都要检查发射器的油门中位是否是最低。

当发射机作出调整时，可能模型的引擎没有运行或电机没有连接，可能会发生失控或意外事故的情况。

## 5. 2.4GHz System 2.4G系统



**AFHDS2A** stands for "Automatic Frequency Hopping Digital System 2A". This highly sophisticated radio transmission system will guarantee you a long range, jamming free and long battery life experience. This is the result of years of research and testing and makes Fly Sky one of the world leader in the market.

AFHDS2A是第二代增强版自动跳频数字系统的简写。它是一个高度精密的遥控信号传播系统，这个系统能够提供良好的距离，抗干扰能力强并且耗电量低。它是世界领先的遥控制造商之一——富斯遥控模型技术有限公司研发并测试多年的成果。

### RF specifications:

RF range: 2.405-2.475GHz  
Channel bandwidth: 500KHz  
Number of channels: 142  
RF power: less than 20dBm  
RF mode: AFHDS 2A(Automatic Frequency Hopping Digital System 2A)  
Modulation type: GFSK  
Antenna length: 26mm\*2(dual antenna)  
RX sensitivity: -105dBm

### 参数说明：

频率范围：2.405-2.475GHz  
波段宽度：500KHz  
波段个数：142个  
发射功率：不高于20dBm  
发射模式：AFHDS2A(第二代增强版自动跳频数字系统)  
编码方式：GFSK  
天线长度：26毫米\*2(双天线)  
接收机灵敏度：-105dBm

### Danger:

Misuse of this radio system can lead to serious injuries or death. Please read completely this manual and only operate your radio system according to it.

### 警告!

错误使用遥控设备将导致严重的伤害甚至死亡。请在使用前完整阅读这本使用手册，并且在使用过程中严格按照此手册的说明操作。

The 2.4GHz radio band has a completely different behavior than previously used lower frequency bands. Keep always your model in sight as a large object can block the RF signal and lead to loss of control and danger. The 2.4GHz RF signal propagates in straight lines and cannot get around objects on its path. Never grip the transmitter antenna when operating a model as it degrades significantly the RF signal quality and strength and may cause loss of control and danger

该2.4G无线电波段完全不同于之前所使用的低频无线电波段。使用时要保持您的模型产品飞行在您的视线范围内，因为大的障碍物将会阻断无线电频率信号从而导致遥控失控和危险。2.4G无线电频率信号是沿直线传播的，它不能绕过障碍物进行传播。在使用过程中，严禁紧握发射机天线，否则将会大大减弱无线电传播信号的质量和强度，导致遥控设备失控和危险。

### Danger:

Always turn on the transmitter first then the receiver. When turning off the system, always turn off the receiver first then the transmitter. This is to avoid having the receiver on itself as it may pick a wrong signal and lead to erratic servo movements. This is particularly important for electric powered models as it may unexpectedly turn on the motor and lead to injuries or death.

### 警告!

每次使用时,必须先打开发射机,然后再给接收机通电。停止使用时,必须先断开接收机电源,然后再关闭发射机。这样操作可以避免接收机接收到错误信号而导致的伺服器无规律的抖动。这对于电动模型来说尤为重要,因为它有可能导致马达突然转动而致使人员伤亡。

## 6. System Characteristic 系统特征

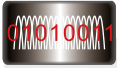

This radio system works in the frequency range of 2.405 to 2.475GHz. This band has been divided into 142 independent channels. Each radio system uses 16 different channels and 160 different types of hopping algorithm. By using various switch-on times, hopping scheme and channel frequencies, the system can guarantee a jamming free radio transmission.

此系统工作频率范围是2.405到2.475GHz。整个波段被分为142个独立频点。每套遥控系统使用16个不同频点和160种不同的跳频算法。通过开机时间不同，跳频规律不同和使用不同的频点，遥控系统能避免干扰传播信号。



This radio system uses a high gain and high quality multi directional antenna. It covers the whole frequency band. Associated with a high sensitivity receiver, this radio system guarantees a jamming free long range radio transmission.

此系统采用高质量的增益天线，覆盖整个波段带宽。配合高灵敏度接收机，系统能有效的避免远距离传播信号的干扰。



Each transmitter has a unique ID. When binding with a receiver, the receiver saves that unique ID and can accept only data from that unique transmitter. This avoids picking another transmitter signal and dramatically increases interference immunity and safety.

每台发射机有一个唯一的ID码，当和接收机对码之后，接收机保存这个唯一的ID码并且只接受从这个ID码发射机发出的信号。这样可以避免接收到别的发射机信号，大大增强抗干扰能力和安全性。



This radio system uses low power electronic components and a very sensitive receiver chip. The RF modulation uses intermittent signal transmission thus reducing even more power consumption. Comparatively, this radio system uses only a tenth of the power of a standard FM system.

此系统使用低功率电子元件和高灵敏度接收机芯片。无线频率模块采用间歇性信号传播，因此大大降低了发射功率。比较而言，此系统功耗仅为FM版本的十分之一。



AFHDS2A system has the automatic identification function, which can switch automatically current mode between single-way communication mode and two-way communication mode according to customer needs. The two-way communication mode with data return function can help users understand current working status better and make the flight more enjoyable.

AFHDS2A系统具备单一双向自动识别功能，根据用户需求自动切换单-双向通信模式。在双向通信模式下，具备信息回传功能，能更好的掌握模型的当前工作状态，增加操控乐趣及安全性。



AFHDS2A has built-in multiple channel coding and error-correction, which improve the stability of the communication, reduce the error ratio and extend the reliable transmission distance.

AFHDS2A系统内置多重信道编码和纠错算法，有效的提高了通信稳定度，减小通信误码率，增加可靠传输距离。

## 7. Transmitter specifications 发射机参数

### Transmitter specifications:

- Number of channels: 6  
 Model type: fixed-wing/glider/ helicopter  
 Channel resolution: 1024 steps  
 Power supply: 6V (1.5V AA x4)  
 Low voltage warning: Icon blinks and alarm less than 4.2V  
 Icon blinks and short alarm less than 4.0V  
 No-operation warning: The transmitter will alarm if there is no operation more than one minute.  
 Antenna length: 26mm\*2 ( dual antenna)  
 Color: Black  
 Size: 174\*89\*190mm  
 Weight: 392g  
 Certification: CE, FCC

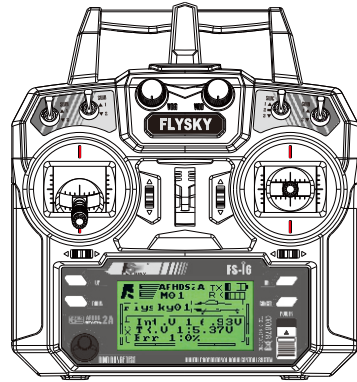

### 机种参数

1. 通道个数 : 6
2. 适合机种 : 固定翼/滑翔机/直升机
3. 数据分辨率: 1024级
4. 输入电压: 6V (1.5V AA x 4)
5. 低电压报警功能: 低于4.2伏图标闪烁并且长报警  
低于4.0伏图标闪烁并且短报警
6. 关机报警功能: 开机无操作1分钟后蜂鸣器报警
7. 天线长度: 26毫米\* 2(双天线)
8. 外观颜色: 黑色
9. 外形尺寸: 174\*89\*190毫米
10. 整机重量: 392克
11. 安规认证: CE, FCC

## 8. Receiver specifications 接收机参数



### SPECIFICATIONS :

- Number of channels: 6  
 Model type: fixed-wing/glider/ helicopter  
 RF receiver sensitivity: -105dBm;  
 Modulation: GFSK  
 System type: AFHDS2A/AFHDS  
 Channel resolution: 1024 steps  
 Bind port: yes  
 Power port: yes(VCC)  
 Power: 4.0-6.5VDC  
 Weight: 6.4g  
 Antenna length: 26mm  
 Size: 40.4\*21.1\*7.35mm  
 Color: black  
 Certification: CE, FCC.

### 机种参数:

1. 通道个数 : 6个通道
2. 适合机种 : 固定翼/滑翔机/直升机
3. 接收灵敏度 : -105dBm
4. 调制方式: GFSK
5. 系统模式: 第二代增强版自动跳频  
数字系统(含第一代系统)
6. 数据分辨率: 1024级
7. 对码接口: 有
8. 电源接口: 有(VCC)
9. 电源标准: 4.0-6.5V DC
10. 整机重量: 6.4克
11. 天线长度: 26毫米
12. 外型尺寸: 40.4\*21.1\*7.35毫米
13. 外观颜色: 黑色
14. 安规认证: CE, FCC.

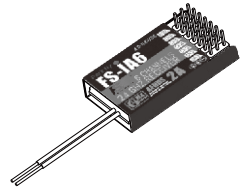

## 9. RX setup introduction

接收机操作说明

### Dual antenna notes



In order to make sure maximum distance between the transmitter and receiver please follow the directions below:

1. The two antennas must be kept as straight as possible. Otherwise, control range will be reduced.
2. The two antennas should be placed at a 90 degree angle to each other, as illustrated in the three pictures below.
3. The antennas must be kept away from conductive materials, such as metal and carbon. A distance of at least 1.5cm is required for safe operation. Conductive materials will not affect the coaxial part of the antenna, but it is important that the coaxials are not bent to a severe radius.
4. Keep antennas away from the motor, speed controller and other noise sources as much as possible.

接收机双天线注意事项：

为了让发射及接收距离更远，请注意以下几点：

1. 尽量保证双天线笔直，否则将会减小控制范围；
2. 双天线的夹角保持在90°(如图三种方式),这并不是精确的垂直角度，重要的是尽可能保持天线互相远离；
3. 天线应该尽可能远离金属导体，至少要有1.5cm左右的距离。轴电缆段不受此限制，但不要过度弯曲；
4. 尽可能保持天线远离电动机、调速器，和其它的噪声源。

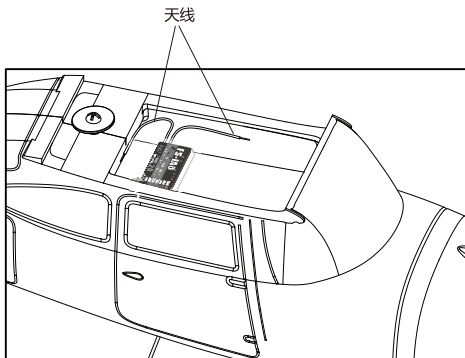
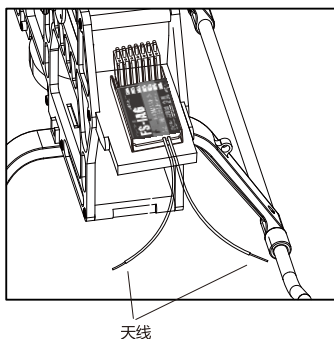
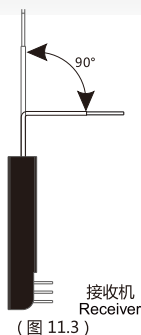
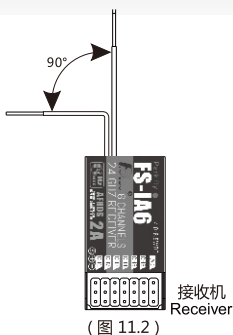
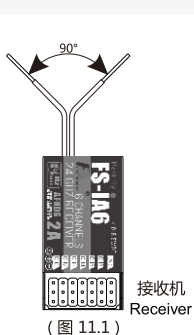

## 10. Receiver and servo connections 接收机与伺服器连接

### 10.01. Receiver and servo connections (aircraft)

飞机模型的接收机与伺服器连接

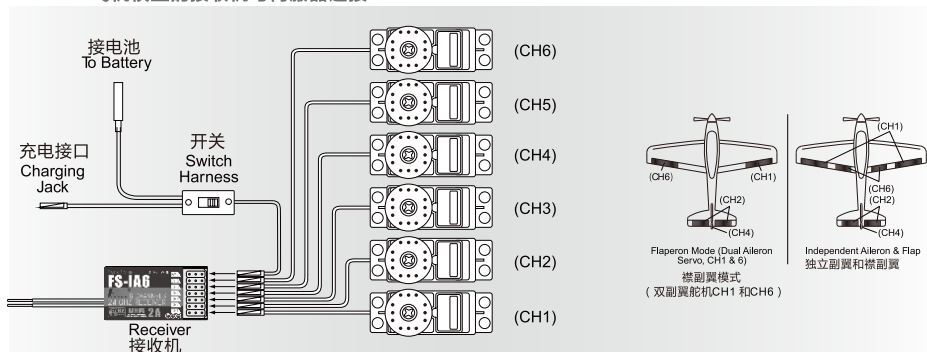

### 10.02 Receiver and servo connections (helicopter)

直升机模型的接收机与伺服器连接

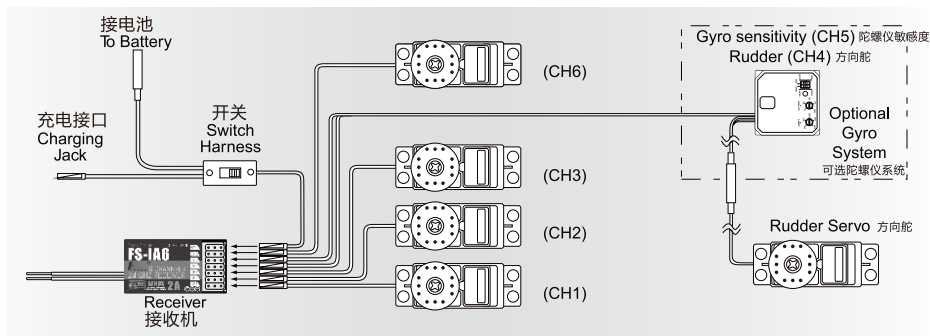

## 11. 2.4GHz Operation notes 2.4G操作注意事项

### 11.01. Binding 对码

The supplied transmitter and receiver are already bound at production time so you don't need to do it. If you are using another transmitter or receiver, you have to first bind them before use as described below:

1. Install batteries in the transmitter and turn it off.
2. Connect the binding jumper to the battery port of the receiver.
3. Connect the battery of the receiver to any channel power supply. The red LED with blink indicating that it is in binding mode.
4. Press and hold the bind key of the transmitter and turn it on.
5. The binding process is finished when the red indicator on receiver flashes more slowly than before. Pull out the binding wire and the red indicator stays on.
6. Disconnect the receiver battery.
7. Turn off then back on the transmitter.
8. Connect all the servos to the receiver and then connect its battery.
9. Check if all servos are working as expected.
10. If anything is wrong, please bind again according above steps.

#### 对码:

所有遥控产品在出厂的时候都已经对好码,您无需再次对码。如果您需要和其他发射机或接收机对码,您必须在使用前按照以下方法对码:

1. 将电池装入发射机然后关闭发射机。
2. 将对码线插到接收机电池通道插口。
3. 将接收机电池连接至接收机任意通道,接收机红色指示灯快速闪烁表明处于对码状态。
4. 按住发射机对码按键不放手,同时打开发射机。
5. 接收机红色指示灯由快闪变成慢闪表明对码成功,拔掉对码线,红色指示灯常亮
6. 断开接收机电源。
7. 关闭发射机电源。
8. 将所有舵机连接至接收机,然后就将电池连接到接收机。
9. 检查是否所有的舵机按照要求工作正常。
10. 如果对码失败,请按以上步骤从头再来。

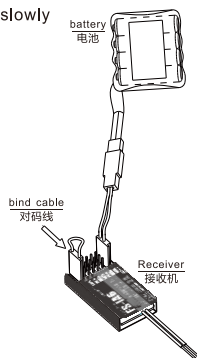

### 11.02 Power on 开机

1. Connect all parts
2. Switch on the transmitter
3. Connect the receiver battery
4. The receiver red LED indicator is solid indicating the presence of a correct signal
5. Use the radio system

1. 连接好所有部件
2. 打开发射机
3. 接通接收机电源
4. 接收机红色指示灯常亮说明信号连接正常。
5. 操作系统可以使用

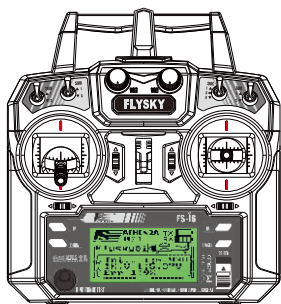

Tx power ON



Power on

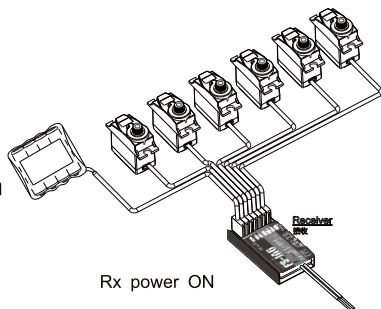

Rx power ON

### 11.03 Shut down 关机

1. Disconnect the receiver battery
2. Switch off the transmitter

1. 断开接收机电源
2. 关闭发射机

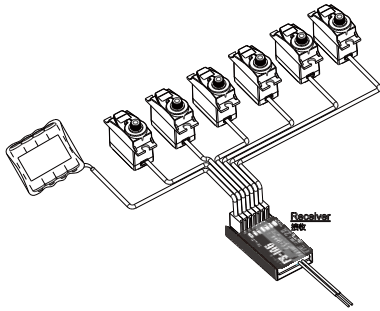

Rx power off



Shut down

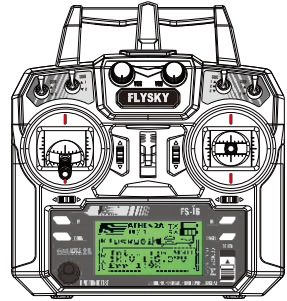

Tx power off

### 12. Definition of key functions 按键定义

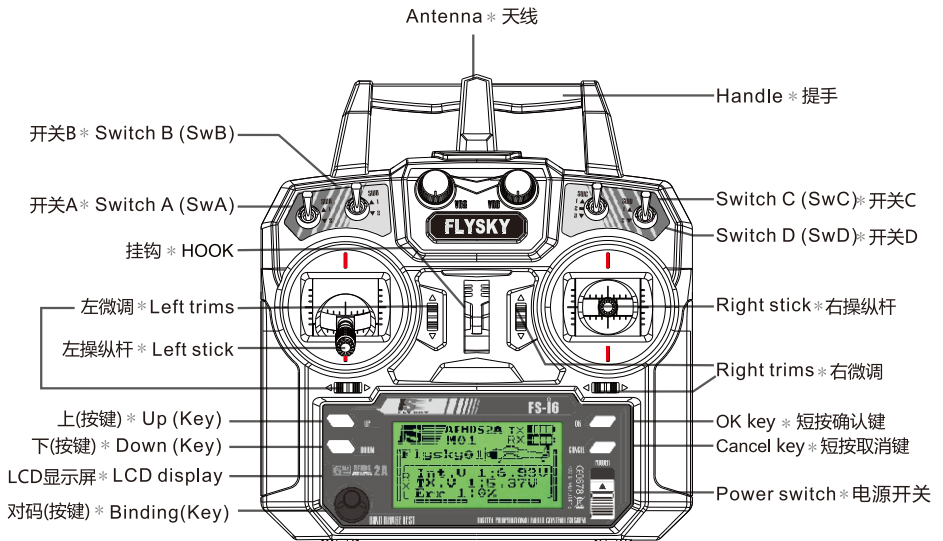



## Definition of key functions

按键定义

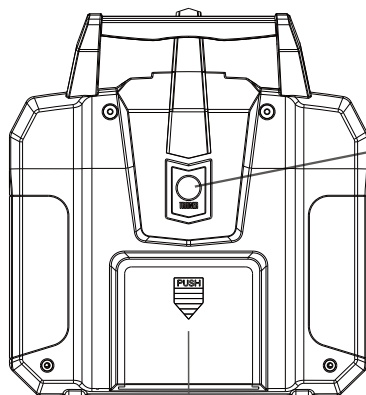
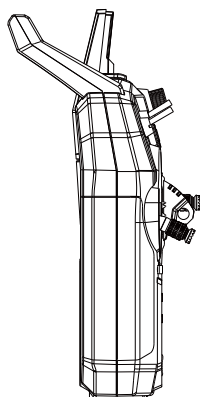

Trainer jack \* 教练接口  
update routine interface  
\* 更新程序接口

电池盒

## 13. Warning 警告

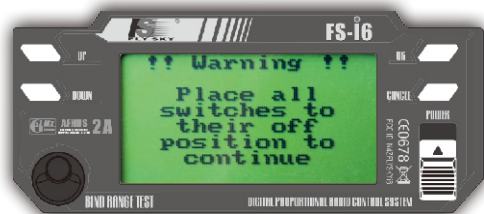

For your safety, the 4 switches of the transmitter must be in their off position and throttle stick must be the lowest position when turning the transmitter on. If not, a warning screen will be displayed until all switches are in the right position.

为了您的安全，开机时发射机上面的四个拨动开关必须在关闭位置，油门摇杆必须在最低位置。如果没有在关闭位置或最低位置，显示屏将会出现报警提示直至所有开关关闭。

## 14. Main screen 开机画面 (双向)



Besides the Fly Sky logo and modulation type (AFHDS2A), the main screen displays the following information:

1. Selected model number (1 to 20): 20 different models can be saved in the transmitter allowing you to instantly switch to 20 different models.
2. Model name: each model can be named with 8 characters name that allow you to easily recognize the associated model.
3. An aircraft or helicopter picture that indicates the type of the selected model.
4. The four electronic trims position.
5. The battery status and voltage. Icon blinks and alarm when the battery voltage drops below 4.2V. Below 4.0V, Icon blinks and alarm shortly.
6. Feedback sensor data from RX (unique character of two-way communication system).

除了富斯商标和AFHDS2A跳频方式外，开机画面还显示以下内容：

1. 选择模型编号(1到20): 发射机可以存储20组不同模型，用户可立即转换20组不同数据。
2. 模型名称: 每一组模型的名称由8个字符组成，用户可以根据模型的名称很容易的找到相关的模型。
3. 所选择的飞机或者直升机的种类的标志。
4. 四个电子微调的位置。
5. 电池的电量状况和电压。当电池电压低于4.2V时，图标闪烁并且长报警，当电池电压低于4.0V时，图标闪烁并且短报警。
6. 接收机反馈的传感器数据（双向特有）。

### 14.01 Main screen 开机画面 (单向)



## 15. Main menu 主菜单



The main menu is separated into two main sections, system setup and functions setup. The system menu allows you to set up the transmitter and manage the 20 models. The function menu is used to set up each model separately. To enter the main menu, long press the "OK" key. Use the "Up" and "Down" Key to select the desired section and press "OK". Then, use the "Up" and "Down" Key to select the desired submenu and press again "OK". Most of the following screen work according to this simple scheme:

1. Use the "OK" key to select the parameter to modify.
2. Use the "Up" and "Down" key to modify the value of the selected parameter.
3. Long press the "Cancel" key to exit and save the new parameters.
4. Short press the "Cancel" key to exit without saving the new parameters.

To return to the previous screen, press the "Cancel" key. You can repeat that operation until the main screen.

主菜单分为两部分，系统设置和功能设置。用户可以进入系统菜单设定发射机和选择20组模型。功能菜单中可分别设置每个模型的功能。

长按“OK”键进入主菜单，按“Up”和“Down”键选择想要的功能，短按“OK”键确认。然后按“Up”和“Down”键选择想要的子菜单，再次短按“OK”键确认。

接下来大多数的屏幕操作都是按照这个简单的步骤进行：

1. 通过“OK”键选择需要修改的参数。
2. 按“Up”和“Down”键修改参数的数值。
3. 长按“Cancel”键退出并保存新的参数。
4. 短按“Cancel”键退出但不保存新的参数。

按“Cancel”键返回上一级菜单。用户可以重复这个操作直至回到主菜单。

## 16. System settings 系统设置

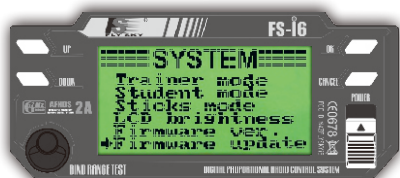

### 16.01. Model select 模型选择



Use this function to select the active model among the 20 available models. Doing so, you can set up and save all required parameters to fly 20 different models and switch instantly between them.

此功能是从存储的20组模型中选择一个当前使用的，用户可以设定和存储所需要的20组不同模型的数据，用户可立即转换不同数据。

## 16.02. Model name 模型名称

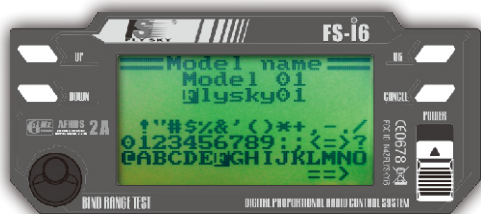

Use this function to change the name associated with the currently selected model. Press "OK" to select the letter of the name to change then use the "UP" "DOWN" key to change the selected letter.

此功能可修改当前选择的模型名称。按“OK”键选定需要修改的字母，按“UP”“DOWN”键选择替换该处的新字母。

## 16.03. Type select 类型选择

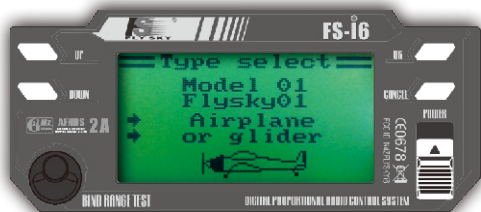

Use this function to select the type of aircraft or helicopter the current model is controlling. The "Functions setup" menu will be filled accordingly. The transmitter supports airplanes (including V tail configuration), fixed and variable pitch helicopters and Swash AFR (Collective and Cyclic Pitch Mixing) 90°, 120° and 140°.

此功能可选择当前模型的类型：飞机或者直升机。对应的功能设置也会相应的修改。此款发射机支持飞机模式（包括V型尾翼结构），固定和可变螺距的直升机以及CCPM（直升机螺距混控系统）90°、120°和140°。

## 16.04. Model copy 模型复制

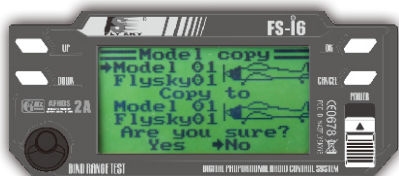
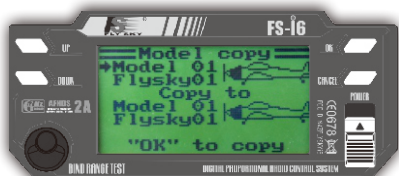

Use this function to copy one model settings to another. The target model settings will be deleted and replaced by the source model settings. Since this command is destructive, a confirmation will be asked. Press "OK" to execute the copy, select "Yes" with "UP" "DOWN" key then press "OK" again to confirm.

此功能可将选定的模型的数据复制到目标模型，目标模型的原始数据将被永久删除，并且被目标源的模型设置所代替，因为指令是无法修复的，所以会有一个询问提示，再次确认是否执行该操作。按“OK”键执行该命令，按“UP”“DOWN”键选择“Yes”再次按“OK”键确认操作。

## 16.05. Model reset 模型重置

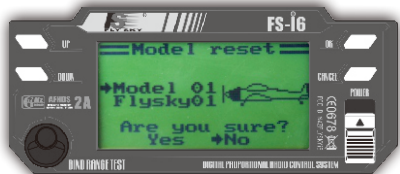

This function will reset the currently selected model to its default. The other models will not be affected. This can be useful when a setup is going nowhere and needs a fresh start. Since this function is destructive, a confirmation will be asked.

此功能将当前所选择的模型数据恢复到默认值，其他的模型的数据不会被修改。设置调乱时可使用该功能进行初始化设置。当前所选择模型的数据将被永久删除，并且无法恢复，因此会有一个询问提示，再次确认是否执行该操作。

## 16.06. Trainer mode 教练模式

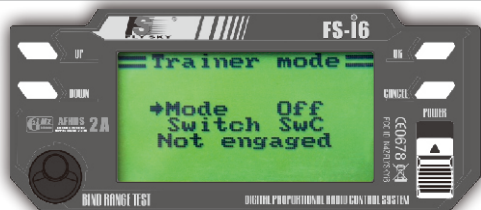

This function allows you to connect 2 transmitters together using a dedicated cable connected to the back interface. One is the instructor (the master) and the other is the student (the slave). Once enabled, switching on the selected trainer switch will set up the remote as the instructor and use the trainer transmitter to control the model. As soon as the trainer switch is turned off, the student transmitter regains control. To be effective, the 2 transmitters have to use the same radio mode (see below).

此功能允许用户通过教练线连接两台发射机一同控制。一台发射机为教练控制，一台发射机为学员控制。一旦开启此功能，教练开关打开时，教练可通过自己的发射机控制模型。当教练开关关闭时，学员恢复控制权。

## 16.07. Student mode 学员模式

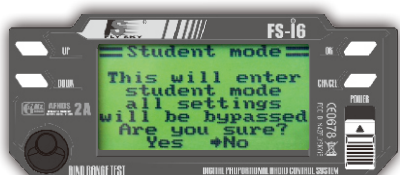
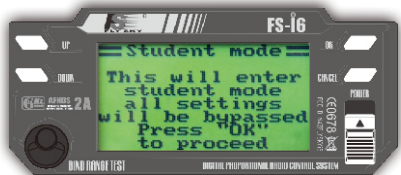

This function works together with the trainer mode. Once enabled, all mode settings are bypassed and the sticks position is sent directly to the instructor's transmitter. At that time, the student transmitter must not control any model directly and any receiver bound to the trainer transmitter must be turned off. Bypassing all student settings allows both student and instructor to share the instructor settings to avoid any glitch when switching between the student and its instructor.

此功能和教练功能一同使用。一旦开启此功能，学员机上所有数据都被锁定，操纵杆的数据直接由教练机定义。而且学员发射机一定不能直接控制任何模型，任何与教练发射机对上码的接收机必须关闭。学员机上所有的设置数据将被锁定，教练机和学员机共享教练机上的设置数据防止教练开关打开时教练机和学员机的脉冲干扰。

## 16.08. Sticks mode 操纵杆模式



With this function, you can choose among 4 different sticks modes. The 4 first channels are mapped to the selected sticks according to your flying habits (left or right handed for example).

此功能有四种不同操纵杆模式供选择。第一组操作杆模式的通道已经在图上标明出来，用户可根据飞行习惯自行选择(例如左手油门或者右手油门)。

## 16.09 Rx setup 接收机设置

### 16.09.01 AFHDS 2 单双向选择



This function is used to set one-way or two-way communication.

此功能用于设置单向或双向通信

### 16.09.02 RX Battery 接收机电源电压

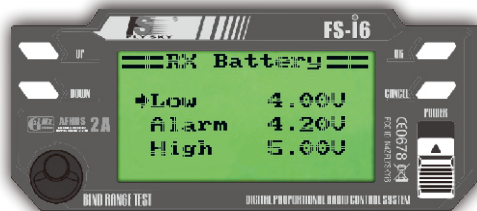

**Low voltage:** set the minimum voltage value. The battery is empty when the actual battery voltage value is lower than this value.

**Alarm voltage:** set the alarm voltage. An audible alarm rings and the receiver battery icon in the top tray blinks when the actual battery voltage value is lower than this value.

**High voltage:** set the maximum voltage value. The battery is in full charge state when the actual battery voltage is equal to this value.

此功能用于设置接收机电源电压状态

**低电压:** 设置电压值，当电池电压低于该数值时，显示电池处于没电状态。

**警报电压:** 设置电压值，低于此电压可以听见警报并且屏幕顶部上方的接收机电池标识开始闪烁。

**高电压:** 设置电压值，当电池电压为该电压值时，显示电池处于满电状态。

## 16.09.03 Fail Safe 失控保护



This function is used for setting the data of failsafe. Once the signal of receiver is lost, the one or more servos will back to pre-set position. "turn off" means the relevant servos will keep the last position when the signal is lost. Setting methods:

Short press "OK", choose one channel to set failsafe function, if the channel is in the needed position, and keep it, short press "OK", then the position of servo will be saved. "ALL Channels" is used for setting all activated channels at a time. Press "Cancel" after finishing all setting to save the failsafe data.

此功能用于设置失控保护数据，万一接收机丢失信号，接收机将设置一个或多个舵机到预先设定的位置。“关闭”意味万一接收丢失信号，相关联的舵机将会保持最后收到的位置。**设置方法：**

短按“OK”键进入一个通道设置失控保护功能，如果激活设置通道到需要的位置，保持该位置，短按“OK”键舵机的位置将保存。“ALL Channels”选项用于一次性设置所有激活的通道，设置完成需长按“Cancel”取消键，保存失控保护数据

## 16.09.04 Sensors list 传感器列表

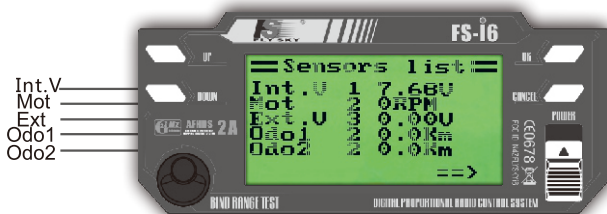

It shows all sensors' type, code and value, it can connect 15 sensors at most.

显示所有链接上的传感器类型、编码和数值，最多可链接15个传感器

## 16.09.05 Choose Sensors 选择传感器

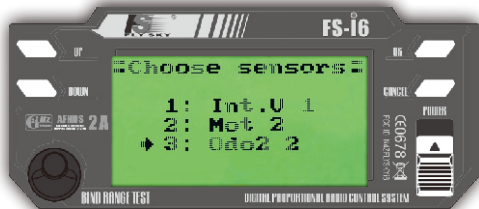

Main screen can show 3 sensors' value, this function can select sensor which need to show, if you don't select sensor, it will show the default one.

主显示屏最多可以显示3个传感器的数值，此功能可选择需显示的传感器，若未选择，则显示默认传感器。



## 16.09.06 Speed-distance 速度 & 距离



### Speed sensor:

Select the rotation speed sensor to use. If none is selected, this function is disabled.

### Set rotation length:

Set the vehicle travel distance corresponding to one rotation speed sensor. This distance is used to control the virtual speed and odometers sensors.

### Reset odometer:

Touch "Reset odometer 1" or "Reset odometer 2" to reset the corresponding odometer.

Odometer 1: it is used for recording the distance traveled by the vehicle one time

Odometer 2: it is used for recording total distance traveled by the vehicle.

### 传速传感器

选择转速传感器.如果没有选择,该功能将被禁用.

### 每圈长度

设置旋转一圈车辆的行程.该距离用于计算虚拟速度和里程表传感器.设置模型车每圈的能走的距离(单位:毫米)。

### 里程表清零

“复位里程表1”或“复位里程表2”，可用于清零相应的里程表内的数值。

里程表1：可作为单次里程表，记录每次使用时模型车跑的里程。

里程表2：可作为总里程表，累计记录所有的里程。

## 16.09.07 i-BUS Setup 设置 i-Bus



This function is used to expand data channel

此功能用于扩展数据通道

## 16.09.08 Servos Freq 舵机频率



This function is used to set servo's frequency

此功能用于设置舵机频率



## 16.10. LCD brightness 显示屏亮度



Adjust the screen contrast according to the surrounding light environment.

屏幕亮度对比度可根据适合周围光线环境的需求调整。

## 16.11. Firmware version 固件版本

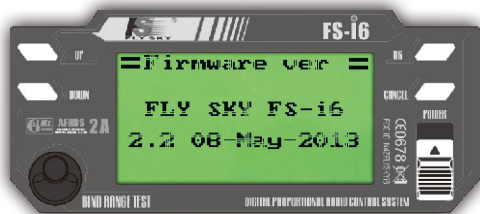

This screen displays the firmware version and date. This allows you to know if a newer version is available for update (see below).

此屏幕显示的是当前固件的版本和日期，用户在网站上可以看到是否有更新的版本可供升级。

## 16.12. Firmware update 固件升级



Prior activating this function, connect the USB cable between the back interface of the transmitter and a PC computer. A confirmation will be asked since all functions will be halted. Turn off any receiver before entering this mode. To exit this mode, simply turn off then back on the transmitter.

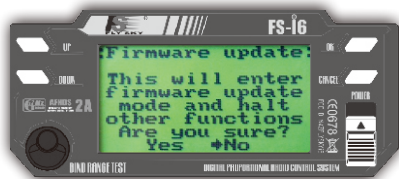

先启动此功能，然后用USB线将发射机背后的接口与电脑连接。所有功能停止之后，会有一个询问提示，确认是否执行该操作。进入此模式前，请关闭所有接收机。如需退出此模式，直接关闭发射机。

## 16.13. Factory reset 恢复工厂设置

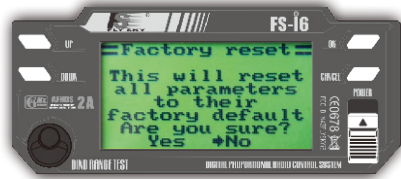

This function will restore the whole transmitter settings to their factory default. All system and modes settings will be lost. Since this function is destructive, a confirmation will be asked.

此功能可恢复发射机全部设置到出厂默认值，所有的系统设置和功能设置数据将被永久删除，并且无法恢复，因此会有一个询问提示，再次确认是否执行该操作。

## 17. Functions settings 功能设置

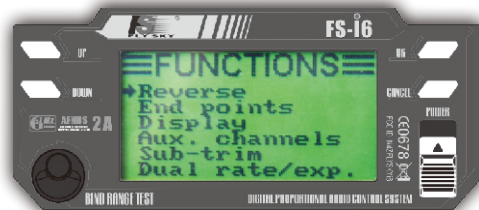

### 17.01. Reverse 正逆转



This function allows you to reverse a channel. Set all channels according to your model mechanics.

用户可通过此功能倒置通道，模型上所有舵机的方向可以通过此设置改变。

## 17.02. End points 舵机最大行程

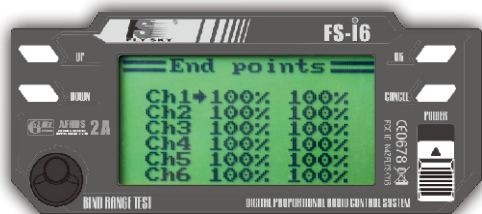

This function sets the lower and upper extents of all channels. Select the channel number with the "OK" key and the lower or upper extent by moving the corresponding stick or variator to the desired direction. Select each extent value according to your model mechanics.

此功能可以调整所有通道范围的大小。按“OK”键选择通道，根据需要用用户的模型结构移动对应的拨动开关或者旋钮调整每一个通道的数值范围的大小。

## 17.03. Display 显示

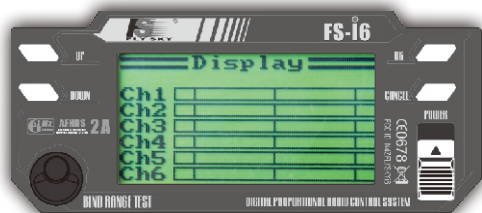

This screen displays the status of all the 6 channels like they are transmitted to the model. It's includes all the mode settings and algorithms if the student mode is not activated.

此屏幕显示的是六个通道的情况与操控模型的实际情况相同。教练模式没有激活的情况下，此处显示的是本机所有的设置和算法。

## 17.04. Auxiliary channels 辅助通道

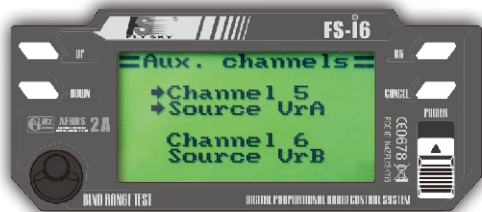

This function let you choose the source of the channels 5 and 6. It can be a variator or a switch. If a switch is selected, an off switch will transmit the lower extent of the channel and an on switch the upper extent. If a variable pitch helicopter is in use, the channel 6 is unavailable. If a helicopter gyroscope is activated, the channel 5 is unavailable.

此功能可选择第五、第六通道的控制来源。可以是一个旋钮或者是一个拨动开关。如果选择拨动开关，开关关闭时传播信号为通道的较低值，开关打开时传播信号为通道的较高值。如果使用的是可变螺距的直升机，第六通道是不能使用的。如果是使用陀螺仪的直升机，第五通道是不能使用的。

## 17.05. Sub-trim 微调

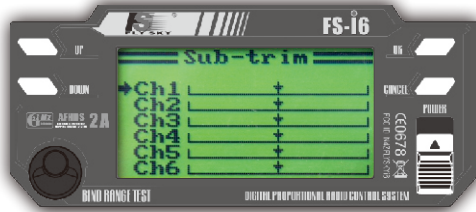

This function allows you to adjust the middle point of each servo. This is especially useful when this middle point cannot be mechanically fine adjusted.

此功能可调整每个通道对应舵机的中位。特别是当机械上无法调整时，这个功能非常有用。

## 17.06. Dual rate / exponential 双重比率/指数



This function lets you set up the transfer function of the channel 1, 2 and 4 in both normal and sport mode. Use the fly mode switch to change mode. The rate selects the desired slope coefficient and the exponential the linearity of the curve. This is very useful to decrease the sensitivity near the middle point.

此功能可设置第一、第二和第四通道正常模式和运动模式的转换功能。通过飞行模式开关改变此模式，可根据需要选择理想的倾斜系数和曲线的线性指数。对于减小靠近中位点灵敏度非常有用。

## 17.07. Throttle curve 油门曲线

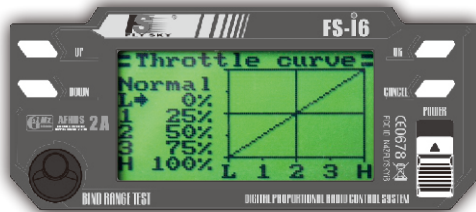

This function sets up the transfer curve of the throttle (channel 3) in both normal and idle modes. Use the idle mode switch to change mode. 5 key points can be adjusted. For example, a beginner may set them to 0%, 5%, 10%, 15% and 20% to decrease the throttle sensitivity and keep its linearity.

此功能可设置油门(第三通道)曲线的普通模式和悬停模式。使用悬停开关改变模式类型。可以调整曲线上的5个主要数值。例如：初学者可分别设置为0%、5%、10%、15%和20%减小油门灵敏度并且可以保持线性。

## 17.08. Pitch curve (variable pitch helicopter only)

螺距曲线(仅螺距可变直升机适用)

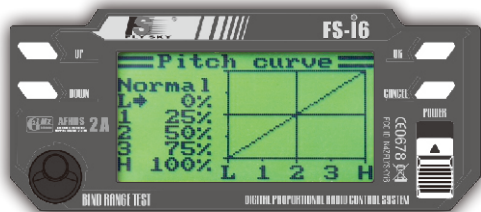

This function is similar to the "Throttle curve" and sets up the transfer curve of the pitch.

此功能和“油门曲线”功能类似，是用来调整螺距曲线。

## 17.09. Swash AFR (variable pitch with Swash AFR helicopter only)

直升机螺距混控系统 (仅适合螺距可变CCPM直升机)

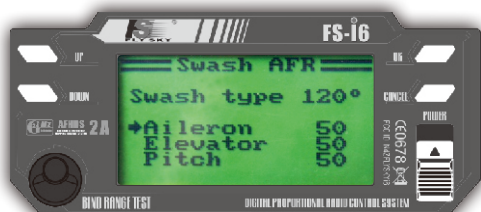

This function sets the proportion of aileron, elevator and pitch in the Swash AFR. To invert one of them, a negative value must be selected.

此功能是设置副翼、升降和螺距的比例。如倒置他们中的任何一个，必须选择相反的数值。

## 17.10. Mix 混控功能



This function allows you to program up to 3 custom channel mixes. The master channel will alter the slave channel. The positive and negative mix set the amount of alteration above and below the middle point. The offset shifts the slave channel by a certain amount.

用户可根据自己的实际需要编写三组混控功能数据。Master对应通道数值会改变Slave对应通道数值。混控设置的正负值设定需要在中点上下做调整。Slave通道的数值会根据现有的数值改变。

## 17.11. Elevon (Airplane only) 升降副翼混控(仅飞机适用)



For the model without tail and the delta wing, you can set mix control rates of Aileron (CH1) and Elevator (CH2) by this function.

如果用户在使用一款没有尾翼和三角翼结构的模型，可使用此功能设置副翼(第一通道)和升降舵(第二通道)的混控比例。

## 17.12. V tail (Airplane only) V型尾翼(仅飞机适用)



For the model without the V-tail, you can set mix control rates of Elevator (CH2) and Rudder (CH4) by this function.

如果用户在使用一款带有V型尾翼结构的模型，可使用此功能设置升降(第二通道)和方向舵(第四通道)的混控比例。

## 17.13. Gyroscope (helicopter only) 陀螺仪设置(仅直升机适用)



This function allows you to activate the gyroscope on the channel 5 and to set up its value for both normal and idle up modes.

用户可在此功能中打开第五通道的陀螺仪，设置普通模式和悬停模式的数值。

## 17.14. Switches assign 开关分配



This function lets you assign a switch to control the fly mode, idle mode and throttle hold functions.

此功能可将拨动开关分别分配给飞行模式，悬停模式和油门锁定功能。







## 17.15. Throttle hold 油门锁定



This function allows you to activate the throttle hold and to choose its value. Once engaged, the throttle stick is ignored and only the selected value is transmitted.

此功能可以激活油门锁定功能并设置油门锁定值。一旦启用，油门摇杆将被锁定。发射机油门量始终为该处设定的数值。

## 18. Packaging content 包装内容

NO:	Model		Sum	Remarks
1	6 channel 2.4G transmitter (FS-i6) 6 通2.4G发射机		1	
2	6 channel 2.4G receiver (FS-iA6) 6 通2.4G接收机		1	
3	User manual 说明书		1	CD
4	Simulator cable 模拟线		1	Optional 可选的
5	Servo (FS-S009) 伺服器		2	Optional 可选的
6	Trainer cable 教练线		1	Optional 可选的

## 19. FCC Statement 声明

### FCC Statement

This equipment has been tested and found to comply with the limits for a Class B digital device pursuant to part 15 of the FCC rules. These limits are designed to provide reasonable protection against harmful interference in a residential installation. This equipment generates, uses and can radiate radio frequency energy and, if not installed and used in accordance with the instructions, may cause harmful interference to radio communications. However, there is no guarantee that interference will not occur in a particular installation. If this equipment does cause harmful interference to radio or television reception, which can be determined by turning the equipment off and on, the user is encouraged to try to correct the interference by one or more of the following measures:

- Reorient or relocate the receiving antenna.
- Increase the separation between the equipment and receiver.
- Connect the equipment into an outlet on a circuit different from that to which the receiver is connected.
- Consult the dealer or an experienced radio/TV technician for help.

To assure continued compliance, any changes or modifications not expressly approved by the party responsible for compliance could void the user's authority to operate this equipment. (Example use only shielded interface cables when connecting to computer or peripheral devices).

This equipment complies with Part 15 of the FCC Rules. Operation is subject to the following two conditions:

- (1) This device may not cause harmful interference, and
- (2) This device must accept any interference received, including interference that may cause undesired operation.

### Caution!

The manufacturer is not responsible for any radio or TV interference caused by unauthorized modifications to this equipment. Such modifications could void the user authority to operate the equipment.





**Digital propotional radio control system**

<http://www.flysky-cn.com>

Copyright ©2013-2017 Flysky co., ltd